

Pt100 Temperature Sensors Type TF101

General

TF101 temperature sensors use EN 60751/IEC 60751 platinum resistance temperature detectors (RTD). For precise temperature measurement the Platinum Re-

sistance Thermometer offers the best overall advantages in repeatability and stability over a long period. High accuracy allows replacement of a sensor without any need for re-adjust of the connected measuring devices or thermostats.

Types / Description

TF101N

-70°C...+500°C



Platinum resistance temperature sensor on ceramic substrate intended for installation into any housing depending to user's requirements. Very small and quick sensor, only suitable for further treatment. Notice: do not cut the sensor leads. Thermal response time refer to manufacturer data:

$T_{0,9}$ in the air 10 s, in water <1 s.

Part number: 019061

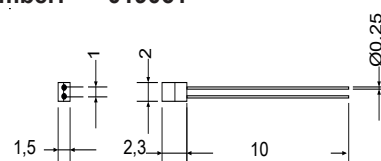

TF101K

-50°C...+170°C



Platinum resistance temperature sensor on ceramic substrate protected by a heat-shrinkable sleeve and with PTFE isolated stranded wire. The TF101K version can be installed in motor or transformer windings. When build-in into windings do not pressure the sensor element. Precautions should be taken to protect sensor and extension leads against push and pull forces. Thermal response time $T_{0,9}$ in the air 100 s, in water 19 s.

With 2-wire connection and cable-length of 2 m there is a temperature-failure of approx. $0.51 \Omega = 1.32 K$ caused by the line resistance.

Cable length: 2000 mm

Weight: 10 g

Part numbers: **T223154** 2-wire
T223134 3-wire

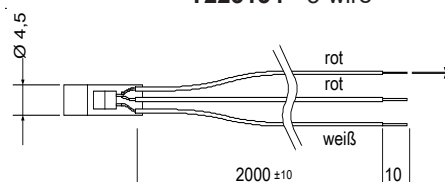

TF101U2

-30°C...+105°C



-50°C...+170°C

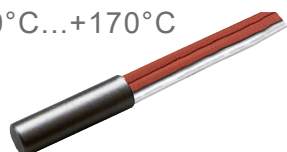

-30°C...+80°C



Sensors TF101U2 are encapsulated in a stainless-steel-shell V4A. They are suitable for measuring temperatures in fluids, at surfaces or for inside or outside applications. The protection class is IP 66. The version with PVC-insulated cable (3 x 0,25 mm² in one cable) can be easily wired. The maximum ambient temperature is 105 °C.

The sensor with cable 30mm (PVC) can be mounted in terminals in switchgear cabinets to measure temperature in enclosure.

The version with PTFE-insulation (3 x 0,14 mm² single wires) withstands peak-temperatures up to 200 °C

Weights: PVC: 2 m = 50 g, 10 m = 250 g,
30 mm = 15 g
PTFE: 2 m = 20 g

Part numbers:

T223051	3-wire	2 m	PVC	-30...+105 °C
T223058	3-wire	10 m	PVC	-30...+105 °C
T223052	3-wire	2 m	PTFE	-50...+170 °C
T223047	2-wire	30 mm	PVC	-30... +80 °C

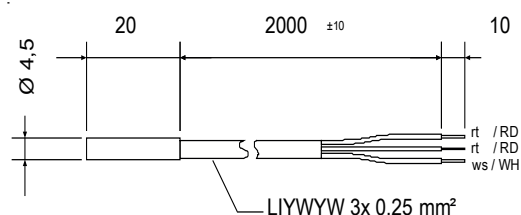

TF101G3

-50°C...+170°C
mit Gewinde

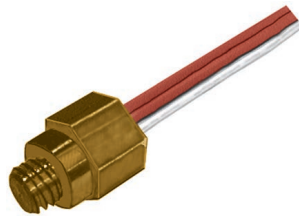

Platinum resistance temperature sensor on ceramic substrate built into a M6 brass threaded bush, especially suitable for being screwed into metal, e.g. for monitoring temperature of heat sinks or heating plates. Please note that there will be a measuring error due to the design, as the sensor can lose heat via the connection strand.

Cable length: 2000 mm

Weight: 21 g.

(Dimensions see Dimension illustrations)

Part number: T223143 3-wire

TF101ZG2

-50°C...+170°C



Platinum resistance temperature sensor built into steel tube V4A, 1/2 inch, suitable for installation in pipes. Thermal response time $T_{0,9}$ in the air 255 s, in water 45 s.

Suitable for transmission in 2- or 3-wire technique.

Weight 120 g

(Dimensions see Dimension illustrations)

Part number: T223137
110 mm depth of immersion

TF101R

-20...+70°C



Sensor for measuring ambient temperatures inside or outside.

Protection class IP 54. Cabling can be connected in 2- or 3-wire technique.

Housing W x H x D = 65 x 50 x 38 mm

Weight: app. 70 g

Part number: T223060

Technical Data

Nominal resistance
Temperature coefficient
Class B, DIN 43 760
Test voltage
Extension leads

Shrink sleeve
max. temperature at sensors
with max. 170°C

100 Ω at 0 °C
3,85 x 10⁻³/K (see table)
 $\Delta\vartheta = \pm (0,3 + 0,005 \vartheta)$ [°C]
2,5 kV AC (not 019061 and T223047)
PTFE; silver-plated stranded copper wire 0,14 mm²
or PVC isolated copper wire
Kynar
200 °C (max. 170 h)

Cabling

ZIEHL thermostats of TR series are generally insensitive to interference in the sensor line. Occasionally, however, undesirable switching is unavoidable, especially when temperature is near the switching point. For this reason it is highly recommended that cables are not laid parallel to power current lines over long distances. When appropriate, cables should be screened or twisted together.

Line-resistance

With RTD sensors the resistance of the connecting cable should be considered, otherwise there is an measuring error. The resistance must be compensated. The resistance of a connecting cable can be calculated as follows:

$$R [\Omega] = 2 \times l / (k \times A),$$

l = cable length [m],
 k = conductivity [S x m/mm²] e.g. Cu = 56,
 A = cross sectional area [mm²]

For example copper-wire: $l = 50$ m, cross sectional area 1 mm²: $R = 2 \times 50 / (56 \times 1) = 1,79 \Omega$, Resulting error = $1,79 \Omega / 0,385 \Omega \times K = 4,6$ K.

Linecompensation

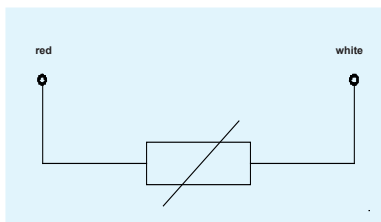

2-wire technique

With 2-wire connection the line resistance is compensated for by a potentiometer in the thermostat, by programming (e.g. TR122D, TR600) or via wiring an external resistor. The advantage of the possibly simpler and more economical running of just two wires is counteracted by the disadvantage of the manual compensation required in the case of longer wiring. Differences in resistance caused by temperature changes cannot be compensated.

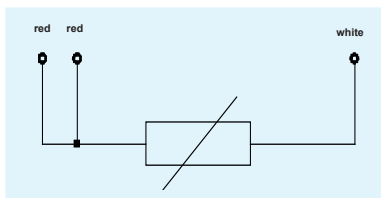

3-wire technique

With 3-wire connection, a third wire (sense) connected to the sensor registers the drop in voltage in one line. For compensation of line resistance it is assumed that the voltage drop in the second line is identical (i.e. the same wire and same wire temperature). Compensation is then performed automatically. Possible changes of resistance in the line due to temperature changes are also compensated for.

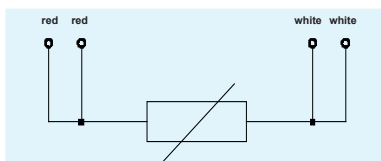

4-wire technique

With 4-wire connection, impressed current flows via two wires to the sensor. Via a two sensor line the drop in voltage is measured directly at the sensor. Possible differences in the sensor connection wiring can be disregarded. A disadvantage is the higher costs involved in running 4 wires.

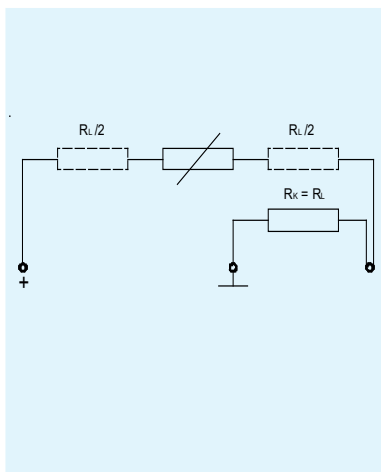

Kombination of 2- and 3-wire technique

When connecting 2-wire-sensors to units with 3-wire input, the line resistance can be compensated by connecting a compensation resistor (R_k) between ground and sense-input. R_k must have the same value as the resistance of the line. The sensor then has to be connected to the + and the sense- input. R_k must be lower than the permitted resistance for 1 line of the 3-wire-input.

Units requiring 3-wire configurations can also be operated by 2-wire sensors. The sensor input is simply shortened. The line resistance need not be compensated.

3-wire sensors can be used as 2-wire sensors, simply by omitting one wire. 2-wire sensors can be branched at any desired position in a 3 or 4-wire connection system. In this case though, the line resistance of the two wires from the branching point to the sensor is not compensated.

ZIEHL thermostats, series TR are designed for use with 2 or 3-wire connection.

Pt100 resistance table

Basic values in Ω for measuring resistors Pt 100 according to DIN/ IEC 751

$^{\circ}\text{C}$	Ω	$^{\circ}\text{C}$	Ω	$^{\circ}\text{C}$	Ω	$^{\circ}\text{C}$	Ω	$^{\circ}\text{C}$	Ω	$^{\circ}\text{C}$	Ω
-200	18,49	0	100,00	200	175,84	400	247,04	600	313,59	800	375,51
-190	22,80	10	103,90	210	179,51	410	250,48	610	316,80	810	378,48
-180	27,08	20	107,79	220	183,17	420	253,90	620	319,99	820	381,45
-170	31,32	30	111,67	230	186,82	430	257,32	630	323,18	830	384,40
-160	35,53	40	115,54	240	190,45	440	260,72	640	326,35	840	387,34
-150	39,71	50	119,40	250	194,07	450	264,11	650	329,51	850	390,26
-140	43,87	60	123,24	260	197,69	460	267,49	660	332,66		
-130	48,00	70	127,07	270	201,29	470	270,86	670	335,79		
-120	52,11	80	130,89	280	204,88	480	274,22	680	338,92		
-110	56,19	90	134,70	290	208,45	490	277,56	690	342,03		
-100	60,25	100	138,50	300	212,02	500	280,90	700	345,13		
- 90	64,30	110	142,29	310	215,57	510	284,22	710	348,22		
- 80	68,33	120	146,06	320	219,12	520	287,53	720	351,30		
- 70	72,33	130	149,82	330	222,65	530	290,83	730	354,37		
- 60	76,33	140	153,58	340	226,17	540	294,11	740	357,42		
- 50	80,31	150	157,31	350	229,67	550	297,39	750	360,47		
- 40	84,27	160	161,04	360	233,17	560	300,65	760	363,50		
- 30	88,22	170	164,76	370	236,65	570	303,91	770	366,52		
- 20	92,16	180	168,46	380	240,13	580	307,15	780	369,53		
- 10	96,09	190	172,16	390	243,59	590	310,38	790	372,52		

Pt1000 Temperature Sensor

The Pt1000 sensor is the "big brother" of the Pt100 sensor. Its nominal resistance at 0°C is 1000Ω . Resistance values of the whole series are higher by a factor of 10. The sensor is used in the same way as the Pt100 sensor. Its dimensions are slightly larger (4 x 5 un-insulated). Thermostats and sensors for Pt1000 on request.

Pt1000 resistance table

values see Pt100, multiplied by the factor of 10.