

Operating Manual TR660IP

updated: 2019-09-24 / sm
 from Firmware: 0-00

- Pt100, Pt1000, PTC temperature relay with integrated webserver and display

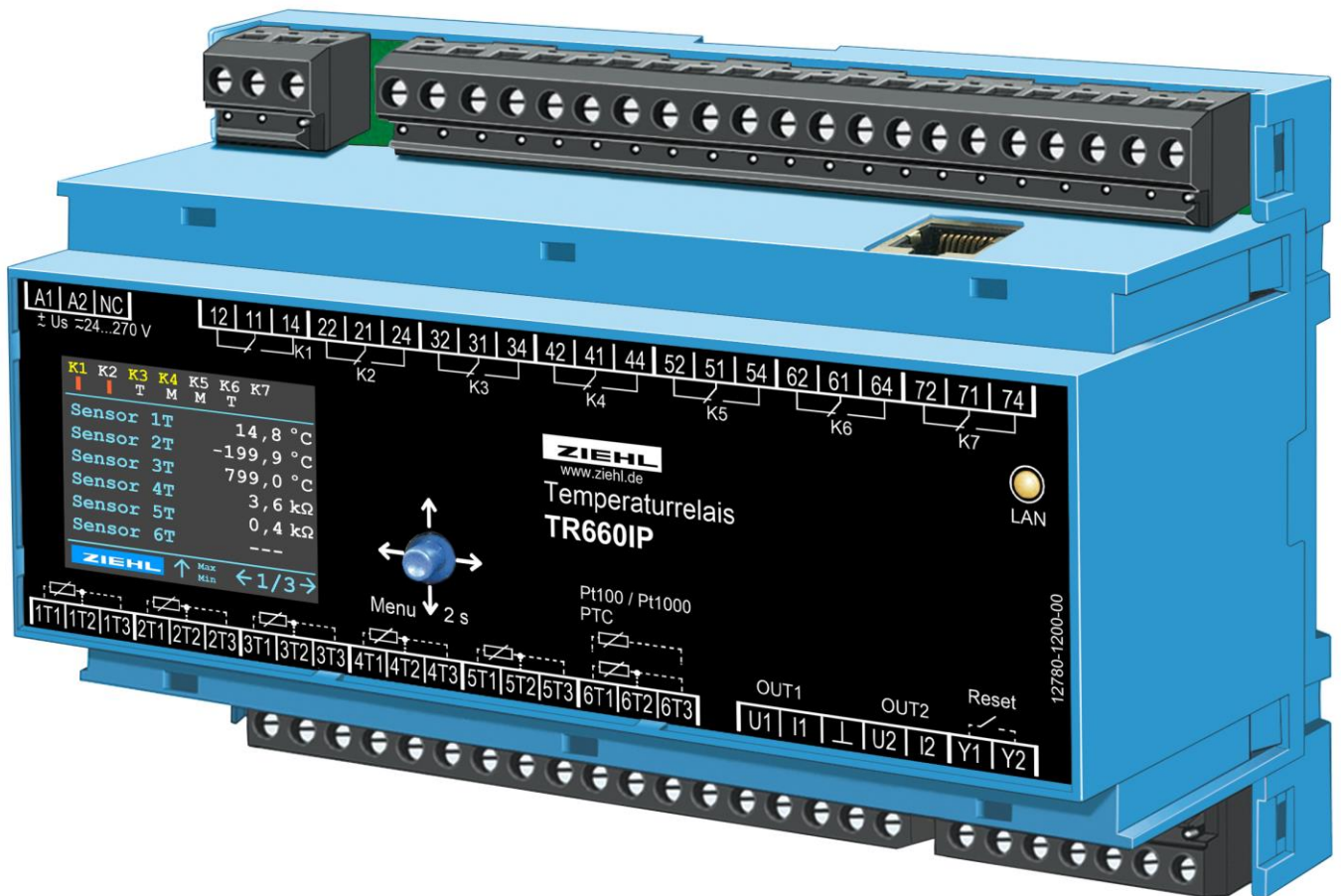

Table of contents

1	General Notes	3
2	Display and controls	3
3	Pre-sets	3
4	Application and short description	4
5	Overview of functions	4
6	Connecting diagram	5
6.1	TR660IP Analog	5
6.2	TR660IP RS485	5
6.3	Ethernet.....	6
7	Important Information	6
8	Installation	7
9	Commissioning	7
9.1	Notes on operation	7
9.2	Switch on device / select language and date	7
9.3	Device on the network	7
9.3.1	Find the device in the network	8
9.3.2	Call via web browser.....	8
9.4	Wire line adjustment	8
10	Operation	8
10.1	Program selection.....	8
10.2	Description of the parameters	10
10.3	Code lock / code reset	12
10.4	Description of the display pages	12
10.4.1	Measured value page (1/3).....	12
10.4.2	Sensor to alarm assignment (2/3).....	12
10.4.3	Info page (3/3)	13
10.5	Special functions.....	13
10.5.1	2 of x	13
10.5.2	Rate of change of temperature (ROCOT)	13
10.5.3	Cyclic relay test	13
10.6	Simulation.....	13
10.7	Firmware update.....	14
10.8	Alarm counter	14
10.9	Temperature statistic	14
10.10	Program update	14
10.11	Modbus	14
11	Error search	14
12	Disposal	15
13	Technical data	15
14	Housing V8	18

1 General Notes

Compliance with the following instructions is mandatory to ensure the functionality and safety of the product. If the following instructions given especially but not limited for general safety, transport, storage, mounting, operating conditions, commissioning and disposal / recycling are not observed, the product may not operate safely and may cause a hazard to the life and limb of users and third parties.

Deviations from the following requirements may therefore lead both to the loss of the statutory material defect liability rights and to the liability of the buyer for the product that has become unsafe due to the deviation from the specifications.

2 Display and controls

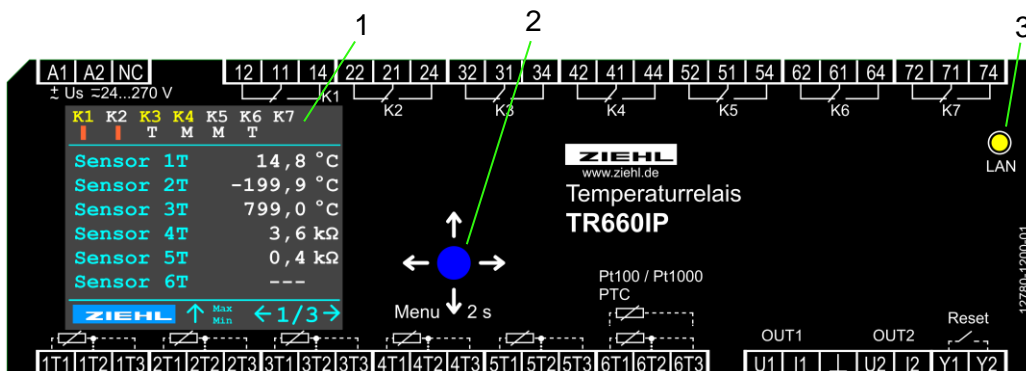

1. Display

- K1 ... K7
 - white font => relay released
 - yellow font => relay energized
- coloured bar below the relay name
 - bar increasing => delay alarm on active
 - bar decreasing => delay alarm off active
 - bar flashes red => manual intervention necessary, alarm can be reset (push button up, or external switch on Y1 + Y2)
 - "M" => relay is in manual mode (depending on the colour of the relay name; relay energized (yellow) relay dropped (white))
 - "T" => cyclic relay test active
- When measured value is highlighted in orange
 - sensor value is above the limit value
- **ERR**
 - There is at least 1 error (detailed description of the active error is shown on page 4)

2. Operating element – joystick button

3. LED Ethernet connectivity

3 Pre-sets

The pre-set programs cover most applications. The required program can easily be selected via the menu ([push button down >2s -> programs](#)). Alternatively, the program can be selected via the web server ([page configuration](#)).

4 Application and short description

The TR660IP is used particularly advantageous wherever several Pt100, Pt1000 sensors or PTC thermistors are to be evaluated simultaneously:

- Motors or generators, also with simultaneous monitoring of bearing or e.g. exhaust temperatures
- Transformers, also with additional core temperature monitoring
- Machinery and equipment

Switchgear type TR660IP monitor up to 6 sensors simultaneously. The user can assign several limit values to the 7 output relays almost arbitrarily. The assignment sensor / relay is very variable programmable. Basic settings such as the monitoring of 3 sensors to the same limit with common message (e.g. when used on motors or transformers) can be easily selected via the default configurations.

5 Overview of functions

- All measured values can be read at once
- Easy operation with joystick button
- Measuring and monitoring range Pt100, Pt1000 -199,9 ... +800,0°C, PTC
- 6x sensor inputs (Pt100, Pt1000, PTC), optionally 2 or 3 – wire technology
- 7x relay outputs (1 changeover each)
 - Alarm K1 (11/12/14) ... K7 (71/72/74)
- Fault message for sensor break, short circuit and device fault freely configurable on each of the 7 relays
- Modbus TCP
- Wide range power supply AC / DC 24 – 270V
- Integrated web server for the measurement query, configuration and for firmware updates
- 4x analogue output (2x voltage, 2x current) –**TR660IP Analog only**
- RS485 interface (Modbus RTU) –**TR660IP RS485 only**

Functions / settings

Alarm:

- Each sensor can be assigned to each alarm (relay K1 ... K7).
 - However, only equivalent sensor types can be assigned to the same alarm. That means Pt100 and Pt1000 sensors can be combined, but not PTC at the same time.
 - **Caution! The first parameterized sensor specifies the alarm type (Pt sensor or PTC).**
- For each alarm, sensor fault and device fault can be parameterized
- Free adjustable delay times for “Alarm on” and “Alarm off”
- 2 of x
 - The function “2 of x” triggers the alarm only if at least 2 of the sensors parameterized for this alarm fulfil the alarm conditions
 - If only 1 sensor assigned to an alarm, this function cannot be activated.
- Rate of change of temperature (ROCOT)
 - ROCOT slope (°C / s)
 - If the temperature increase between the measured values is higher than the set slope, the respective alarm switches on. Even if the set “alarm on” temperature has not yet been reached.
 - ROCOT time
 - If the calculated value ((slope * time) + current measured value) exceeds the set switch-off temperature, the alarm switches on.
 - ROCOT switch back conditions
 - Actual measured value must be less than “alarm off” and slope must be negative.
- Locked alarm
 - Each alarm can be set to “locked” yes or no

- Relay function
 - On at alarm
 - Off at alarm
 - Manually on (if a relay is set to “manual”, it permanently retains this state)
 - Manually off

Cyclic relay test

The cyclic relay test is freely adjustable for each relay. It is used on engines for example, to activate fans or pumps in a fixed cycle for the set time, so that they are moved regularly.

6 Connecting diagram

6.1 TR660IP Analog

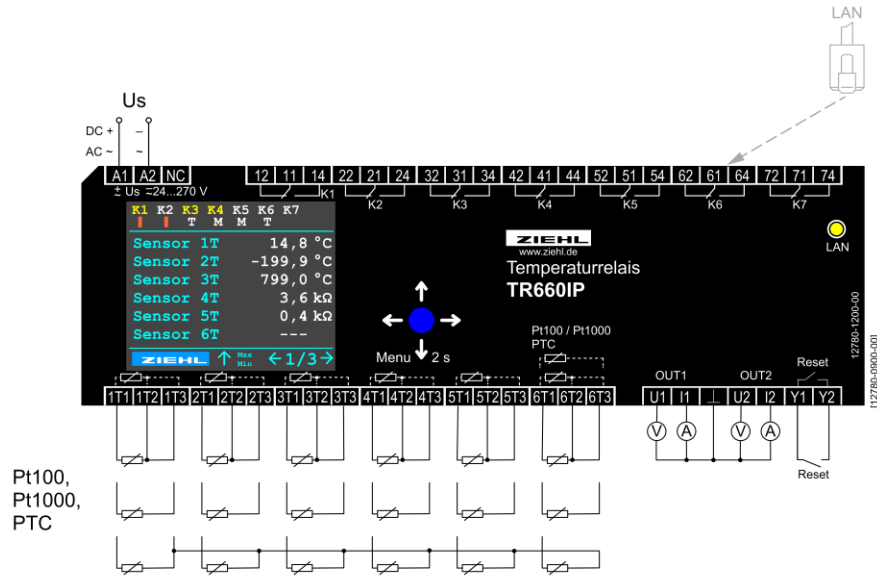

6.2 TR660IP RS485

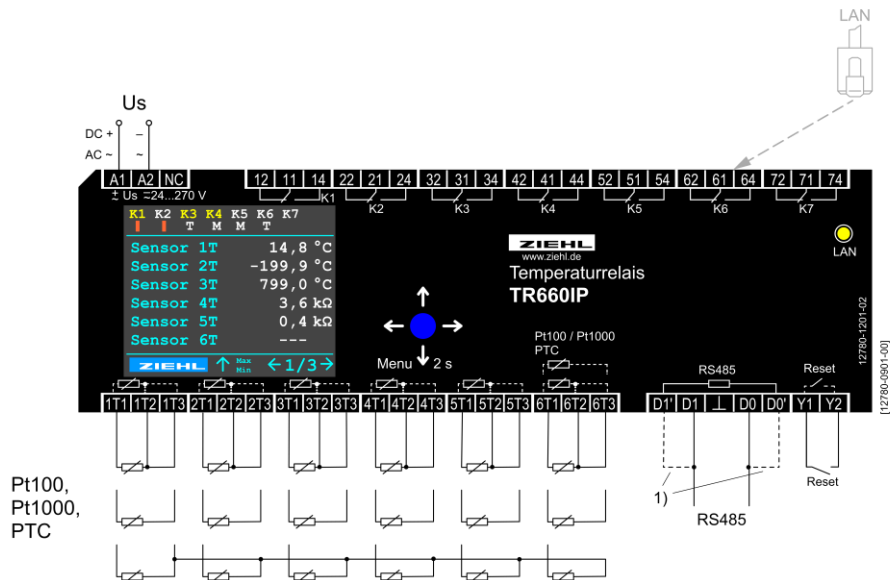

CAUTION! For the last device in the RS485 bus, the bridges „1)“ must be screwed in from D1 to D1' and from D0 to D0'. Wire bridges are not included.

6.3 Ethernet

Ethernet socket for network cable.



7 Important Information



DANGER!

Hazardous voltage!

Will cause death or serious injury. Turn off and lock out all power supplying this device before working on this device.



If the temperature sensors are installed in transformers or motors with a voltage > 300V, they must have a double or reinforced insulation suitable for the measurement.



All wires (sensors, reset, ethernet) that are >30m must be shielded. The shield must be earthed on the side of the device



Reference to isolation of input and output as well as relay contacts: Unless otherwise noted, the devices have basic insulation accordingly the measurement insulation voltage of the device. When higher isolation or safe separation is required for the application, this must be ensured due to additional measures.



Attention!

The temperature sensors are connected to terminals 1T1, 1T2, 1T3 etc.

These pluggable contacts have a special contact material and may only be used for connecting the sensors.

To use the equipment flawless and safe, transport and store properly, install and start professionally and operate as directed.

Only let persons work with the equipment who are familiar with installation, start and use and who have appropriate qualification corresponding to their function. They must observe the contents of the instructions manual, the information which are written on the equipment and the relevant security instructions for the setting up and the use of electrical units.

The equipment is built according to DIN / EN and checked and leave the plant according to security in perfect condition. If, in any case the information in the instructions manual is not sufficient, please contact our company or the responsible representative.

To maintain this condition, you must observe the safety instructions in this instruction manual titled "Important Information". Failure to follow the safety instructions may result in death, personal injury, or property damage to the equipment itself and other equipment and facilities.

Instead of the industrial norms and regulations written in this instruction manual valid for Europe, you must observe out of their geographical scope the valid and relevant regulations of the corresponding country.

8 Installation

- mount on 35 mm mounting rail according to EN 60715
- wall-mount with 3 x screws M4
- connecting wires refer to the connection plan to prevent miss-operation and malfunction.



A circuit-breaker or switch must be situated within easy reach of the unit and fused. Installation excess current protection should be ≤ 10 A.

Observe the maximum permissible temperature when installing in the control cabinet. Leave enough space for other equipment or heat sources. If cooling becomes difficult, e.g. by close proximity of devices with increased surface temperature or obstruction of the cooling air flow, the permissible ambient temperature is reduced.

9 Commissioning

9.1 Notes on operation

↑ Push Button up...

Display page 1/3: min/max values

Menu: scroll up

Parameter: increase value

Locked alarm: >2s = reset

← Push Button left...

Display page: previous display page

Menu: back

Parameter: navigate to the left

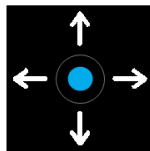

→ Push Button right...

Display page: next display page

Menu: call submenu / parameter

Parameter: navigate to the right

↓ Push Button down...

Display page: Press and hold for 2s, menu is displayed

Menu: scroll down

Parameter: decrease value

9.2 Switch on device / select language and date

When you first start the device, the language selection appears. After the desired language has been selected, the current date and time setting will appear. These settings are required for the correct operation of the alarm counter. If the date has not been set, the alarm counter will show the year 1970. After these settings have been made, the monitoring starts. The settings for the language, date and time can be changed at any time in the menu ([settings](#) -> [language](#) / [date](#) / [time](#)) or via web browser.

9.3 Device on the network

If the TR660IP is connected to a network via Ethernet, the measured values and parameterization can be made via the web browser on a computer. Basic knowledge of network technology is required for the configuration.

9.3.1 Find the device in the network

Network with DHCP server

After connecting to the network, the device automatically receives an IP address.

Query IP address on the device:

- In menu mode, select the menu item “network” or on the 3rd display page
- Settings for the network parameters DHCP, IP address and subnet mask can be viewed and changed.

Set network without DHCP server / manual IP address

The relevant network parameters can be set and changed directly on the device:

- In menu mode, select the menu item “network”
- Settings for the network parameters:
 - Set DHCP to “off”
 - Set the IP address and subnet mask

Connection

Start the web browser on computer and insert the IP address in the address bar.

9.3.2 Call via web browser

After calling the IP address, the device logs in the web browser.

9.4 Wire line adjustment

To compensate the line resistance short circuit the wires nearby the sensor, measure resistance and enter this value for line resistance. With 2-wire connection and a common line for all signals, all sensor measuring currents will be added on the common line. Thus the value of the compensation line resistance RK must be calculated as follows:

$RK = (n+1) \times RL/2$ (RL = resistance of two wires, n = number of sensors)

10 Operation

10.1 Program selection

Depending on the application, a program with the appropriate default settings can be loaded on the TR660IP. Settings procedure on the device: [push button down >2s -> programs -> select application area -> select program](#).

Setting procedure via web browser: [page “configuration” -> select suitable program from dropdown menu -> by clicking on “save” the selected program is loaded](#).

Pr	Description	sensors	alarms
1.00	Trafo save 3x Pt100 same settings as Pr1 TR250	1T = Pt100 2T = Pt100 3T = Pt100 4T = off 5T = off 6T = off	K1 = fan with cyclic test K2 = pre-alarm K3 = tripping K4 = sensor-/ device error
1.01	Trafo save 1x Pt100, 2x PTC same settings as Pr3 TR250	1T = Pt100 2T = PTC 3T = PTC 4T = off 5T = off 6T = off	K1 = fan with cyclic test K2 = pre-alarm K3 = tripping K4 = sensor-/ device error
1.02	Trafo save 3x Pt100 same settings as Pr4 TR250	1T = Pt100 2T = Pt100 3T = Pt100 4T = off 5T = off 6T = off	K1 = Sensor 1T K2 = Sensor 2T K3 = Sensor 3T K4 = device error
1.03	Trafo save 4x Pt100	1T = Pt100 2T = Pt100 3T = Pt100	K1 = fan with cyclic test K2 = pre-alarm + error K3 = tripping winding

		4T = Pt100 5T = off 6T = off	K4 = tripping core
1.04	Trafo save 4x Pt100	1T = Pt100 2T = Pt100 3T = Pt100 4T = Pt100 5T = off 6T = off	K1 = core K2 = pre-alarm K3 = tripping winding K4 = sensor-/ device error
1.05	Trafo save 4x PTC	1T = PTC 2T = PTC 3T = PTC 4T = PTC 5T = off 6T = off	K1 = fan with cyclic test K2 = pre-alarm + error K3 = tripping winding K4 = tripping core
1.06	Trafo save 3x PTC	1T = PTC 2T = PTC 3T = PTC 4T = off 5T = off 6T = off	K1 = pre-alarm K2 = tripping winding K3 = tripping core K4 = sensor-/ device error
1.07	Trafo save 3x PTC	1T = PTC 2T = PTC 3T = PTC 4T = off 5T = off 6T = off	K1 = fan with cyclic test K2 = pre-alarm K3 = tripping winding K4 = sensor-/ device error
2.00	Motor save 3x Pt100	1T = Pt100 2T = Pt100 3T = Pt100 4T = off 5T = off 6T = off	K1 = pre-alarm K2 = tripping K3 = sensor-/ device error K4 = not used
3.00	other... 6x Pt100 Single allocation	1T = Pt100 2T = Pt100 3T = Pt100 4T = Pt100 5T = Pt100 6T = Pt100	K1 = sensor 1T K2 = sensor 2T K3 = sensor 3T K4 = sensor 4T K5 = sensor 5T K6 = sensor 6T K7 = sensor-/ device error
3.01	other... 6x PTC Single allocation	1T = PTC 2T = PTC 3T = PTC 4T = PTC 5T = PTC 6T = PTC	K1 = sensor 1T K2 = sensor 2T K3 = sensor 3T K4 = sensor 4T K5 = sensor 5T K6 = sensor 6T K7 = sensor-/ device error
3.02	other... 6x Pt100	1T = Pt100 2T = Pt100 3T = Pt100 4T = Pt100 5T = Pt100 6T = Pt100	K1 = sensor 1T, 2T, 3T K2 = sensor 1T, 2T, 3T K3 = sensor 4T, 5T K4 = sensor 4T, 5T K5 = sensor 5T K6 = sensor 6T K7 = sensor-/ device error

Tip: When a program is changed, all parameters are reset to “Factory setting” of the selected program. The network settings are retained after a program change. **Do not change the parameters until you have selected the correct program.**

10.2 Description of the parameters

menu	parameter	explanation	setting
program	Preset programs for the areas: 1. Trafo-safety, 2. Motor-safety, 3. others...	Load predefined programs for fast and comfortable setting of the TR660IP	-
sensors 1T ... 6T	type	Setting the respectively connected sensor type	off, Pt100, Pt1000, PTC
	Line-resistance	Line-resistance between device and sensor. Setting in ohms, or as 3-wire with automatic compensation of cable resistance.	3- wire, 0,0 ... 100,0 Ω
Alarm K1 ... K7	Sensors	Assignment of which sensors acts on this alarm.	1T ... 6T
	2 of x	If this function is on, 2 of the assigned sensors must meet the alarm conditions to trigger the alarm. Function can only be activated if 2 sensors are assigned to this alarm.	on, off
	alarm on	Temperature value at which the alarm is triggered. If a PTC is assigned to the alarm, fixed switch-off values for PTC thermistors are used.	-199,9 ... 800,0 °C
	alarm off	Temperature value at which the alarm is switches back. If a PTC is assigned to the alarm, fixed reset values for PTC thermistors are used.	-199,9 ... 800,0 °C
	Delay alarm on	Delay time between reaching the alarm on value and switching the relay.	00:00 ... 59:59 mm:ss
	Delay alarm off	Delay time between reaching the alarm off value and switching the relay.	00:00 ... 59:59 mm:ss
	Relay function	Function how the relay should behave in case of an alarm	On at alarm, off at alarm, manually on, manually off
	Alarm locked	If the function is activated, the alarm must be switched back manually on the device, via the web browser or via an external switch on Y1 + Y2.	on, off
	Sensor error	Selection of sensors for which the relay issues a fault message in the event of a sensor error.	1T ... 6T
	Device error	Activation to report a device error with this relay.	on, off
	ROCOT	Function for switching off at rapid temperature rise. (see ROCOT)	off, °C/s, time
	ROCOT [°C/s]	Parameterization of the line slope between two measured values.	0,1 ... 10,0 °C/s
	ROCOT [Zeit]	Setting the calculation time for the ROCOT time shutdown	00:10 ... 20:00 mm:ss
Cyclic test K1 ... K7	Cyclic test	Activation of the cyclic relay test	on, off
	Delay on	Duration after which time the cyclic test is repeated	00-01 ... 90-00 dd-hh

	Time on	Duration for which the test is active	00:01 ... 23:59 hh:mm
Analog-output (TR660IP Analog only)	OUT 1 voltage	range	0 ... 10V 2 ... 10V
		Sensors that act on this analogue output	1T ... 6T
		Temperature output	Min. temperature, max. temperature
		Zero	-199,9 ... 800,0 °C
		Fullscale	-199,9 ... 800,0 °C
	OUT 1 current	range	0 ... 20mA 4 ... 20mA
		Sensors that act on this analogue output	1T ... 6T
		Temperature output	Min. temperature, max. temperature
		Zero	-199,9 ... 800,0 °C
		Fullscale	-199,9 ... 800,0 °C
	OUT 2 voltage	range	0 ... 10V 2 ... 10V
		Sensors that act on this analogue output	1T ... 6T
		Temperature output	Min. temperature, max. temperature
		Zero	-199,9 ... 800,0 °C
		Fullscale	-199,9 ... 800,0 °C
	OUT 2 current	range	0 ... 20mA 4 ... 20mA
		Sensors that act on this analogue output	1T ... 6T
		Temperature output	Min. temperature, max. temperature
		Zero	-199,9 ... 800,0 °C
		Fullscale	-199,9 ... 800,0 °C
RS485 – Modbus (TR660IP RS485 only)	BUS address	Bus address of the TR660IP	001 ... 247
	Baud rate	Communication speed	4800, 9600, 19200, 57600
	Parity	Parity bit	No, odd, even
	Stop Bits	Number of stop bits	1 ... 2
Network	DHCP	Dynamic Host Configuration Protocol (DHCP) The device gets its IP address from the server	on, off
	IP-address	Manual setting of the IP address in the network	
	Subnet mask	Manual setting of the subnet mask	
Settings	Language	Setting of the language of the display	German, English
	Date	Setting the current date	
	time	Setting the current time	
	Display interval	Duration to update the display	0,1 ... 2,0 s
	Brightness	Display brightness	20 ... 100%
	Dimming time	Duration until the display brightness is reduced	00:10 ... 59:59 mm:ss
	Factory settings	Load the parameters of the current active program	no, yes
Code protection	Code protection so that the settings can be protected Factory setting: 504	on, off	
Simulation	Sensors	Simulation of a single sensor value	
	Relay	Simulation of a single relay state	

Info	Firmware version	Display of the current installed firmware version	
	Serial number	Display the serial number	
	Operating hours	Operating hours of the device	
	Comment	Comment of the customer (setting via web browser only)	
Counter	alarm counter	Alarm counter for each alarm	last 20 alarms
	statistic 1	Sensor statistic (resettable)	
	statistic complete	Sensor statistic (not resettable)	
	reset	Deleting the alarm counter and sensor statistic 1	

10.3 Code lock / code reset

The device can be protected with the code lock against unauthorized changes to the device (via joystick button) ([menu](#) -> [settings](#) -> [code lock](#)). A pin code is used for this (**factory setting: 504**).

Reset pin code / disable code lock,
On the device:

- Switch off the supply voltage
- Push the joystick button up (and keep it pressed)
- Switch on the supply voltage (keep the button pressed)
- After approx. 4s, the reset menu appears, select the code lock and push the button to the right
- Code lock is off, pin code is reset to = 504

Via web interface:

- Open the page system, deactivate code lock and save it with a push on the save button.

10.4 Description of the display pages

10.4.1 Measured value page (1/3)

K1	K2	K3	K4	K5	K6	K7
1T	Sensor	14.8	°C			
2T	Sensor	790.2	°C			
3T	Sensor	-199.0	°C			
4T	Sensor	3.6	kΩ			
5T	Sensor	0.4	kΩ			
6T	Sensor	---				

- Measurements of all 6 sensors at a glance
- Sensor names (7 characters) can be set via web interface
- If a measured value triggers an alarm, it receives a coloured background
- Pt100, Pt1000 sensors can be recognized by the unit „°C“
- PTC thermistors can be recognized by the unit „kΩ“
- Is one of the following signs used instead of the measured value:
 - „---“ is displayed, the sensor is deactivated
 - „>>>“ or „<<<<“ is displayed, the current measured value is larger or smaller than the measuring range
- Joystick button
 - Push short upwards => display page for min. / max. values
 - In the case of a backshift ready locked alarm, push the button 2s upwards to reset the alarm.

10.4.2 Sensor to alarm assignment (2/3)

	1T	2T	3T	4T	5T	6T	Al ein
K1	X		X				20 °C
K2		X					-180.0 °C
K3			X	X			910.8 °C
K4							PTC
K5			X				PTC
K6					X		120.0 °C
K7							

- Tabular assignment of the sensors to the alarms
- X (white) => sensor acts on alarm,
- X (orange) => sensor has exceeded limit,
- R (red) => sensor triggered alarm by the ROCOT function,
- 2 (orange) => two sensors triggered alarm by the function „2 of x“
- E (red) => sensor error (short circuit or sensor break)
- Alarm state of the relays can be seen
- (Kx (white) => relay dropped, Kx (yellow) => relay energized)
- Set alarm limit

10.4.3 Info page (3/3)

10.4.3.1 TR660IP Analog

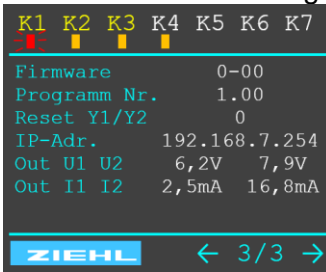

- Currently installed firmware version
- Currently selected program
- Reset input 0 = open, 1 = closed
- Current IP-address of the device
- Actual voltage- / current values of the analogue outputs

10.4.3.2 TR660IP RS485

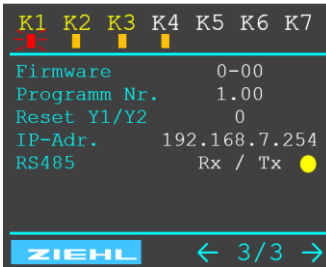

- Currently installed firmware version
- Currently selected program
- Reset input 0 = open, 1 = closed
- Current IP-address of the device
- Activity on the RS485 bus (yellow dot flickering)

10.5 Special functions

10.5.1 2 of x

For each alarm the function “2 of x” can be activated. That is at least two of the sensors associated with the alarm must meet the conditions for the alarm to trigger the alarm.

To activate the function, there must be min. two sensors parametrised for the desired alarm.

10.5.2 Rate of change of temperature (ROCOT)

The ROCOT function sets a new average every 10s. The slope is calculated from the actual and the previous average.

10.5.2.1 Slope (°C / s)

If the calculated slope is greater than the set value, the alarm becomes active.

10.5.2.2 Time (s)

Alarm if the set limit value would be reached at the same slope after the set time. In the time function, the calculated slope is multiplied by the set time. The current measured value is then added to this value. If the result is greater than the set alarm value for “alarm on”, the alarm is triggered.

10.5.2.3 Backshift conditions

If a ROCOT alarm is active, two conditions must be met for the alarm to go back.

- The current measured value must be smaller than the switch-off value for “alarm off”
- The calculated slope must be negative

If both conditions are fulfilled, the alarm switches off again.

10.5.3 Cyclic relay test

For each alarm, a “cyclic relay test” can be activated. This switches the relay according to the set parameters. The cyclic switching ensures a longer service life of pumps and motors, which are normally never in operation. This prevents a defect (sticking due to corrosion, ...) on the connected pumps or motors.

10.6 Simulation

If required (commissioning, troubleshooting, ...), individual functions (sensor values, relay states) can be simulated. The simulation can be started either directly on the device ([menu -> simulation](#)) or via the web interface ([home -> start simulation](#)). The simulation mode is active for 15 min from the last action, or can be shut down directly by the user.

10.7 Firmware update

Firmware updates can be installed via the web browser ([system](#)). If the update notification is active, a message is displayed as soon as a new firmware version is available. If the device is not connected to the internet, the new firmware can be downloaded from the homepage www.ziehl.com. Then the update file can be selected under ([system](#) -> [manual installation](#) -> [select firmware](#)) and carried out via the button “manual update installation”.

10.8 Alarm counter

There are separate alarm counters for each alarm. These alarm counters store the last 20 shutdowns with cause and timestamp. If, instead of the correct time, a date around 1970 is displayed, the set date + time of the real-time clock is not correct. For help see 11. Error search.

10.9 Temperature statistic

The temperature statistic records the residence time of the respective sensor at a certain temperature. There are 20 predefined temperature ranges (10°C each, e.g. 0,0 ... 9,9 °C) from 0,0 up to 199,9 °C. In addition, there is an area for <0,0 °C and one for >200,0 °C. This statistic is available twice resettable via manual reset (or by program change) and cumulated (reset only at program change or set of factory settings).

10.10 Program update

The preinstalled programs can also be updated if necessary. If a newer version is available, it will be displayed in the program table. Here it is directly possible to install the revised version. You can also add new programs via this function.

10.11 Modbus

All devices of type TR660IP have a Modbus TCP interface. The TR660IP RS485 also has a Modbus RTU interface. For more information, see the Modbus operating manual.

11 Error search

Error	Root cause	Help
Relay always switches after a fixed time interval	Cyclic relay test is activated	Deactivate cyclic relay test
Relay does not turn on or off when an alarm is reached	Relay has been parameterized to “manual on” or “manual off”. The display shows below the respective relay an “M”.	Change relay setting (menu -> alarm -> relay function)
The alarm counter displays a date in the range of 1970. In the display (footer) appears again and again „no time“	When starting the device, no correct date / time was set.	<ul style="list-style-type: none">- Set time and date correct (menu -> settings -> date / time)- Via Web interface (network) activate a time server or change settings manual
The display shows ∞Ω instead of the measured value	The associated sensor has a sensor break in one or more wires	Check sensor wires and replace if necessary
	2-wire Pt100 / Pt1000 sensor connected and 3-wire set in the configuration	Check sensor. Change setting to 2-wire with associated line resistance.
The display shows 0Ω instead of the measured value	The associated sensor has a sensor short circuit between 2 wires.	Check sensor wires and replace if necessary
Display shows nothing	<ul style="list-style-type: none">- Supply voltage not connected- Fuse has tripped- Device has an internal defect	<ul style="list-style-type: none">- Connect supply voltage- Replace fuse- Send in the device for repair
„>>>“ or „<<<“ is displayed instead of the measured value	Sensor value is greater (800°C) or less (-200°C) than measuring range	Check sensor and replace if necessary
Display is too dark	The display is dimmed after the set time (menu -> settings -> dimming time), the set brightness	Increase the dimming time (menu -> settings -> dimming time),

	is too low (menu -> settings -> brightness)	increase the display brightness (menu -> settings -> brightness)
Device cannot be parameterized The display shows "code lock" for each parameter	Code lock active	In case of problems with the code lock (code forgotten), the protection can be switched off and the code can be reset to 504 by keeping the button pressed up (approx. 5s) when switching on the supply voltage. Now the code lock can be reset.
No access via ethernet	DHCP is on, but no IP address has been assigned	Check the DHCP server or set a manual IP address
	Invalid network area	Check the address range of the IP address and the subnet mask
No parameters can be changed via the browser	User administration active and no write access for current user available	Assign write rights to the current user or disable user administration. If the admin password is not known, the user administration can be deactivated on the device. Disconnect the device from the supply voltage, push the button up, connect the supply voltage and hold the button (approx. 5s), reset the user administration.
Signal on analogue output 0 ... 10V => 0V, 2 ... 10V => <=1,8V, 0 ... 20mA => 0mA, 4 ... 20mA => <=3,6mA	Sensor short circuit of an associated sensor	Check sensors and repair short circuit
Signal on analogue output 0 ... 10V => 11V, 2 ... 10V => 11V, 0 ... 20mA => 22mA, 4 ... 20mA => 22mA	Sensor break of an associated sensor	Check sensors and repair sensor break

12 Disposal

The disposal must be carried out properly and environmentally friendly in accordance with the statutory provisions.

13 Technical data

Supply voltage Us:	DC/AC 24 ... 270 V, 0/50/60 Hz	
Tolerance	DC 20,4 ... 297 V	AC 20 ... 297 V
Power consumption	< 6 W	< 12 VA
Relay outputs K1 ... K7 (alarm 1 ...7)	Change over	
Switching voltage	max. AC 300 V; DC 300 V	
Inrush current normally open (NO)	AC 15 A 4s 10% ED	
Min. voltage / current	12 V 10 mA	
Conventional thermal current I _{th}	max. 5 A	
Switching power max. AC cos φ = 1	2000 VA	
Switching power max. DC (ohm)	0,3 A 300 V; 0,4 A 120 V; 0,8 A 60 V; 8 A 30 V	
Contact service life, electrical cos φ = 1	cos φ = 1 -> 5 x 10 ⁵ operations at 250 V / 2 A	
Contact service life, mechanical	3 x 10 ⁷ operations	
Short circuit strength (NO)	4 A sluggish or circuit breaker B4	
Short circuit strength (NC)	3,15 A sluggish	
Rated operational current	AC-15	I _e = 3 A U _e = 250 V

UL electrical ratings

DC-13 I_e = 2 A U_e = 24 V
 DC-13 I_e = 0,4 A U_e = 120 V
 DC-13 I_e = 0,2 A U_e = 240 V
 250 V ac, 3 A, general use
 240 V ac, 1/4 hp, 2.9 FLA
 120 V ac, 1/10 hp, 3.0 FLA
 C300

External inputs	approx. DC 18 V / 3,5 mA
Reset input Y1/Y2	Reset of locked alarms (dynamic)

Sensor inputs Pt100, Pt1000 after EN60751

sensor	Measuring range °C		Short circuit in ohms	Sensor break in ohms	Sensor resistance + line resistance
	min.	max.	<	>	max
Pt100	-199,9	800,0	15	400	500
Pt1000	-199,9	800,0	150	4000	4100
PTC			20	20000 *	

*if no value between 3800 and 20000 ohms was measured before

Tolerance ±0,5% from measuring value ±1K
 Sensor current ≤ 1 mA
 Measuring cycle / measuring time t_M <1 s (depending on the number and type of connected sensors)

Analogue output (only TR660IP Analog) U1, U2, I1, I2

Voltage output
 DC 0/2 ... 10V
 accuracy 0,3% of full scale (ab 0,1V)
 Temperature drift < 0,01% / K
 resolution 11,6 Bit <3,1mV
 burden ≥ 1 kΩ

Current output
 DC 0/4 ... 20mA
 accuracy 0,3% of full scale (ab 0,1mA)
 Temperature drift < 0,015% / K
 resolution 11,6 Bit <6,1mV
 load ≤ 500 Ω
 Error load (250 Ω – load) / 250 Ω * 0,3% of current

RS485 interface (only TR660IP RS485)

Protocol Modbus RTU
 Address / bus number 1 ... 247
 Baud rate 4800, 9600, 19200, 57600
 Parity No, odd, even
 Stop bit 1 ... 2

Test conditions EN 61010-1

Rated impulse withstand voltage 4000 V
 Overvoltage category III
 Pollutions degree 2
 Rated insulation Ui 300 V
 Operating time 100 %

Reinforced Insulation (safe separation)
 U_s – relay 6mm (DC 3540V)
 U_s – sensor inputs 6mm (DC 3540V)

Us – electronics, reset, ethernet	6mm (DC 3540V)
Sensor inputs - relay	6mm (DC 3540V)
Sensor inputs – electronics, reset, ethernet	6mm (DC 3540V)
relay - ethernet	6mm (DC 3540V)
Basic insulation	
Relay - Relay	3mm (DC 1420V)
No galvanic separation	Analogue outputs, reset, ethernet
Ethernet- interface	RJ45 connection
Speed	10 / 100 Mbit/s
Real time clock	
Power reserve	> 11 days at 25°C
Time deviation	±3 ppm
EMC tests	EN 61326-1 - industrial environment
EMC emission	EN 61326-1; CISPR 11 class B
EMC immunity	EN 61326-1 - industrial environment
Fast transient disturbances (Burst)	EN 61000-4-4 ±4 kV Pulse 5/50 ns, f = 5 kHz, t = 15 ms, T = 300 ms
Surge immunity test	IEC 61000-4-5 ±2 kV
Electro static discharge immunity test	IEC 61000-4-2 ± 4 kV contact discharge, ± 8 kV air discharge
Installation conditions	
Operating temperature	-20 °C ... +65 °C
Storage temperature	-20 °C ...+70 °C
Altitude	< 2000 m above sea level
Climate resistance	5-85% rel. humidity, no condensation
Wiring temperature	-5 °C ...+70 °C
Vibration resistance EN 60068-2-6	2 ... 13,2 Hz ±1 mm 13,2 ... 100 Hz 1 g 2...25 Hz ±1,6 mm 25 ... 150 Hz 5 g
Housing	Construction type V8, distribution board
Mounting depth	55 mm
Width	8 TE
Dimension (B x H x T)	140 x 90 x 58 mm
Wiring connections single strand	1 x 0,34 - 1,5 mm ² / AWG 22 - 14
Finely stranded with wire end ferrule	1 x 0,1 - 1,0 mm ² / AWG 27 - 16
Stripping length / specify torque	8 mm / 0,5 Nm
Protection class housing / terminals	IP 30 / IP20
Mounting	Snap-on fastening on 35 mm mounting rail acc. EN 60 715 or with M4 screwed attachment (additional bar not included in the scope of delivery)
Weight	app. 370 g

Subject to technical changes

14 Housing V8

Dimension in mm

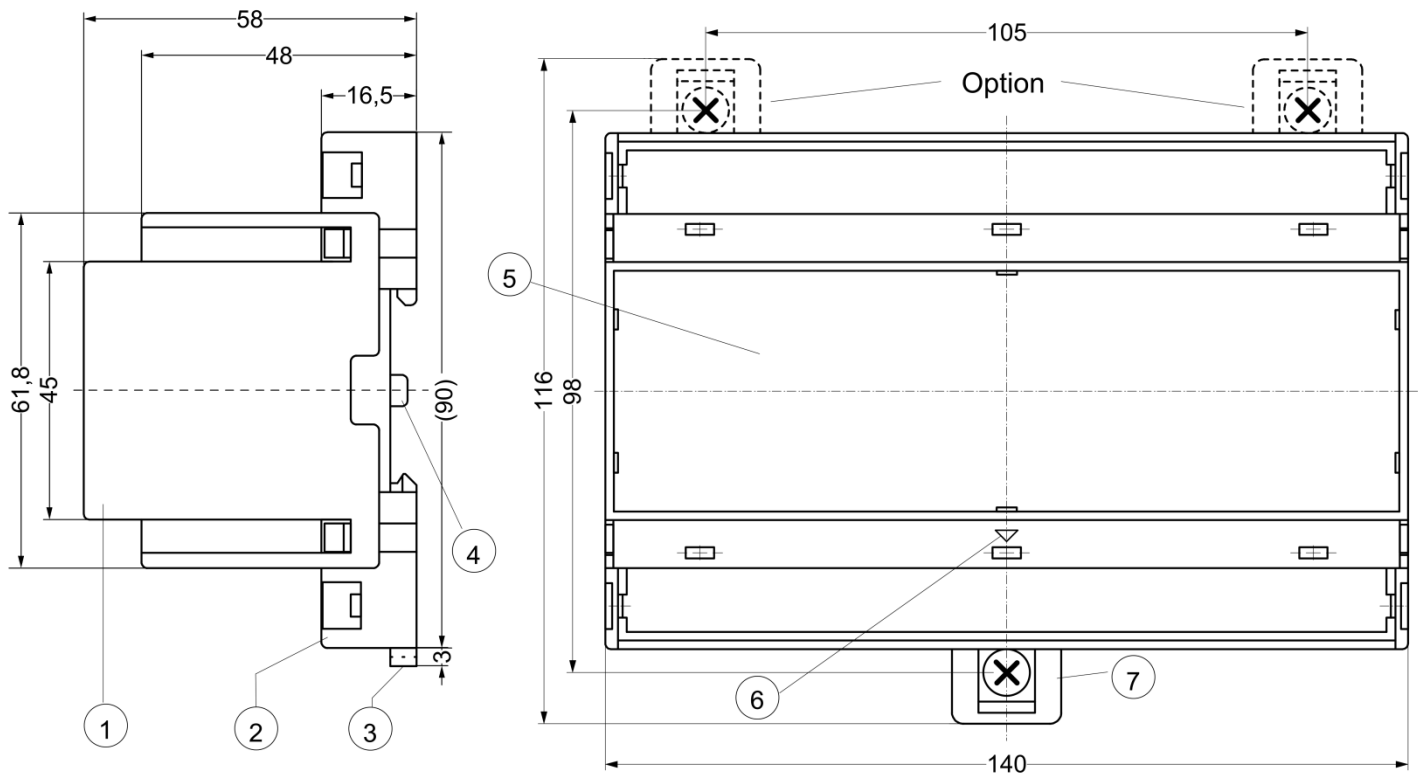

- 1 Oberteil / cover
- 2 Unterteil / base
- 3 Riegel / bar for snap mountin
- 4 Plomben Lasche / latch for sealing
- 5 Frontplatteneinsatz / front panel
- 6 Kennzeichen für unten / position downward
- 7 Riegel bei Wandbefestigung mit Schrauben. Riegelbohrung \varnothing 4,2 mm / for fixing to wall with screws, \varnothing 4.2 mm