

Quick Guide UFR1001E

updated: 2021-03-17 /Sc
from Firmware: 0-16

- NA-protection according to VDE-AR-N 4105:2011+2018-11, power generators at the low voltage grid, TAR medium voltage VDE-AR-N 4110:2018-11 and TAR high voltage VDE-AR-N 4120:2018-11
- for use in power generators at the medium voltage grid according to BDEW
- with selectable vector shift detection and Rate of Change of Frequency (ROCOF,df/dt)



Detailed operating manual see: <https://www.ziehl.com/en/products/?view=detail&detail=54>

- New, Firmware 0-14: Monitoring of zero voltage U_0 (ANSI 59v0)
Pr10 (Austria - TOR producers type A, B, C, D), Pr16 (Belgium - Synergrid C10 / C11)
- New, Firmware 0-15: Function ROCOF revised, new settings in Pr16 (Belgium - Synergrid C10 / C11)
- New, Firmware 0-16: New factory settings in Pr15, NA/EEA-NE7 CH 2020

(display of the firmware function **Inf0** → **Fnr** or press "Set" for >10 s)

1 General Notes

Compliance with the following instructions is mandatory to ensure the functionality and safety of the product. If the following instructions given especially but not limited for general safety, transport, storage, mounting, operating conditions, start-up and disposal / recycling are not observed, the product may not operate safely and may cause a hazard to the life and limb of users and third parties. Deviations from the following requirements may therefore lead both to the loss of the statutory material defect liability rights and to the liability of the buyer for the product that has become unsafe due to the deviation from the specifications.

2 Operating controls

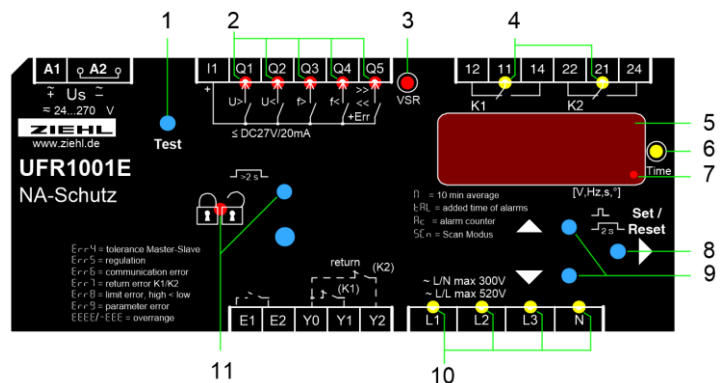

1 Test button

Press shortly	Display test-menu: Relay K1 ($\underline{E5E1}$) or K2 ($\underline{E5E2}$) can be tested independently. (3min without a button is pressed = go back to the normal mode)
---------------	--

2 LEDs Frequency / voltage, above / below threshold (red)

ON, RL or RL Π	Above / below threshold
Flashing, RL or RL Π	OFF-delay doF active

3 LED Vektor shift (VSR, red)

ON, RL	Threshold value for vector shift exceeded
Flashing, RL	OFF-delay doF active

4 LEDs Relay status (yellow)

OFF	Relays de-energized	ON	Relays energized
-----	---------------------	----	------------------

5 Digital display 4-digit (red)

Depending on program, display of current voltage, frequency, vector shift, average value	
Display of alarm message RL, RL Π	Display of error with error code e.g. Err9

6 LED Time (yellow)

ON	A time is displayed
FLASHES	Function rUEF active

7 Backmost decimal point (red)

OFF	Display mode
-----	--------------

Lightning	Menu mode
Flashing	Configuration mode

8 **Set / Reset button**  (in display mode, normal state)

Press shortly	Display of next measured value / alarm counter
Press for > 2 s	Reset, quit error messages
Press for > 4 s	Display of program, e.g. Pr 1
Press for > 10 s	Display of firmware version, e.g. 0- 10



9 **Up / Down button**   (in display mode, normal state)

Press shortly	Change to the menu mode, display of alarm memory (Down) / cumulative time of alarms, standby counter, standby time (Up), pushing of Set button for ≥ 2 s makes a reset of the stored values
Press for > 2 s	Display of MAX (Up) / MIN (Down) measured values, additional pushing of Set button for ≥ 2 s deletes the stored values

10 **LEDs Allocation of the measured value** (yellow)

LEDs	Measured value
Lx and N ON	Voltage (L1 against N, L2 against N, L3 against N)
Lx and Ly ON	Voltage (L1 against L2, L2 against L3, L1 against L3)
Lx flashing quickly	Vector shift (L1, L2, L3)
L1 flashing	Frequency

11 **Sealable button + LED**  

Press for > 2 s	Lock / Unlock
 LED red	Settings and simulation mode are locked, in case of setting attempts Loc is displayed for 3 s
 LED green	Setting and simulation enabled

3 Default settings and firmware version

When changing programs, all parameters are reset to the default settings.

Menu	Parameter / Unit	Default settings								 Users Data
		Low volt. VDE-AR-N 4105:			Medium voltage / high voltage VDE-AR-N 4110 / 4120:2018-11					
		2011	2018	2011	3 AC+N	3 AC	3/2/1AC+N	3 AC		
		3 AC+N	3 AC+N	2/1 AC+N	3 AC+N	3 AC	3/2/1AC+N	3 AC		
			230V	230V	230V	57,7V	100V	230V	400V	
			Pr 1	Pr 2 *	Pr 1	Pr 11	Pr 12	Pr 13	Pr 14	
59.S2 59>S2	U ⁻ Alarm on/off		-	on	-	on	on	on	on	
	U ⁻ Overvoltage	V	-	287	-	69.2	120	287	498	
	H ⁻ Hysteresis	V	-	35.0	-	1.0	1.0	3.0	3.0	
	dRL Response time	s	-	0.10	-	0.30	0.30	0.10	0.10	
	doF OFF-delay	s	-	60	-	60	60	60	60	
59.S1 59>S1	U ⁻ Alarm on/off		on	oFF	on	on	on	oFF	oFF	
	U ⁻ Overvoltage	V	264	264	264	63.5	110	249	430	
	H ⁻ Hysteresis	V	5.0	12.0	5.0	1.0	1.0	3.0	3.0	
	dRL Response time	s	0.10	0.10	0.10	180.0	180.0	60.0	60.0	
	doF OFF-delay	s	60	60	60	60	60	60	60	
59-Av	U ⁿ Alarm on/off		on	on	on	oFF	oFF	oFF	oFF	
	U ⁿ Overvoltage	V	253	253 ³	253	63.5	110	253	438	
	H ⁿ Hysteresis	V	3.0	5.0	3.0	1.0	1.0	3.0	3.0	
	dRL Response time	s	0.10	0.10	0.10	0.10	0.10	0.10	0.10	
	doF OFF-delay	s	60	60	60	60	60	60	60	
27.S1 27<S1	U ₋ Alarm on/off		on	on	on	on	on	on	on	
	U ₋ Undervoltage	V	184	184	184	46.2	80.0	184	318	
	H ₋ Hysteresis	V	5.0	12.0	5.0	9.0	15.5	35.0	61.0	
	dRL Response time	s	0.10	3.00 ³	0.10	2.70	2.70	1.00	1.00	
	doF OFF-delay	s	60	60	60	60	60	60	60	
27.S2 27<S2	U ₋ Alarm on/off		-	on	-	oFF	oFF	on	on	
	U ₋ Undervoltage	V	-	103	-	26.0	45.0	104	179	
	H ₋ Hysteresis	V	-	93.0	-	29.0	50.0	115	180	
	dRL Response time	s	-	0.30 ³	-	0.30	0.30	0.30	0.30	
	doF OFF-delay	s	-	60	-	60	60	60	60	

Menu	Parameter / Unit	Default settings								 Users Data
		Low volt. VDE-AR-N 4105:			Medium voltage / high voltage VDE-AR-N 4110 / 4120:2018-11					
		2011	2018	2011	3 AC+N		3 AC	3/2/1AC+N	3 AC	
		3 AC+N	3 AC+N	2/1 AC+N	3 AC+N	3 AC	3/2/1AC+N	3 AC		
			230V	230V	230V	57,7V	100V	230V	400V	
			Pr 1	Pr 2 *	Pr 1	Pr 11	Pr 12	Pr 13	Pr 14	
F ⁻⁻⁻ 81.S2 81>S2	F ⁻⁻⁻ Alarm on/off		-	oFF	-	oFF	oFF	on	on	
	F ⁻⁻⁻ Overfrequency	Hz	-	52.50	-	51.50	51.50	52.50	52.50	
	H ⁻⁻⁻ Hysteresis	Hz	-	2.40 ²	-	1.40 ²	1.40 ²	2.40 ²	2.40 ²	
	dRL Response time	s	-	0.10	-	0.10	0.10	0.10	0.10	
	doF OFF-delay	s	-	60	-	60	60	60	60	
F ⁻ 81.S1 81>S1	F ⁻ Alarm on/off		on	on	on	oFF	oFF	on	on	
	F ⁻ Overfrequency	Hz	51.50	51.50	51.50	51.50	51.50	51.50	51.50	
	H ⁻ Hysteresis	Hz	1.45 ¹	1.40 ²	1.45 ¹	1.40 ²	1.40 ²	1.40 ²	1.40 ²	
	dRL Response time	s	0.10	0.10	0.10	5.40	5.40	5.00	5.00	
	doF OFF-delay	s	60	60	60	60	60	60	60	
F ₋ 81.S1 81<S1	F ₋ Alarm on/off		on	on	on	oFF	oFF	on	on	
	F ₋ Underfrequency	Hz	47.50	47.50	47.50	47.50	47.50	47.50	47.50	
	H ₋ Hysteresis	Hz	1.00	0.10	1.00	2.40 ⁴	2.40 ⁴	2.40 ⁴	2.40 ⁴	
	dRL Response time	s	0.10	0.10	0.10	0.40	0.40	0.10	0.10	
	doF OFF-delay	s	60	60	60	60	60	60	60	
F ₋₋ 81.S2 81<S2	F ₋₋ Alarm on/off		-	oFF	-	oFF	oFF	oFF	oFF	
	F ₋₋ Underfrequency	Hz	-	47.00	-	47.50	47.50	47.50	47.50	
	H ₋₋ Hysteresis	Hz	-	0.60	-	2.40 ⁴	2.40 ⁴	2.40 ⁴	2.40 ⁴	
	dRL Response time	s	-	0.10	-	0.10	0.10	0.10	0.10	
	doF OFF-delay	s	-	60	-	60	60	60	60	
UFon	UFon Switching conditions		oFF	oFF	oFF	oFF	oFF	on	on	
UonF	UonF on/off		oFF	oFF	oFF	oFF	oFF	oFF	oFF	
	UonF voltage	V	46.0	46.0	46.0	20.0	20.0	46.0	46.0	
u5r 78	u5r Alarm on/off		5tbY	5tbY	5tbY	5tbY	5tbY	5tbY	5tbY	
	u5r Vector shift	°	10.0	10.0	10.0	10.0	10.0	10.0	10.0	
	doF OFF-delay	s	3	3	3	3	3	3	3	
	dEon Suppression time	s	2	2	2	3	3	3	3	
	u5r Number of phases		3Ph	3Ph	3Ph	3Ph	3Ph	3Ph	3Ph	
rocF 81r	rocF Alarm on/off		oFF	oFF	oFF	oFF	oFF	oFF	oFF	
	dFdt delta f / delta t	Hz /s	0.800	2.000	0.800	2.000	2.000	2.000	2.000	
	PER periods		20	20	20	20	20	20	20	
	dRL Response time	s	0.10	0.10	0.10	0.10	0.10	0.10	0.10	
	doF OFF-delay	s	60	60	60	60	60	60	60	
U-0 59v0	U-0 Alarm on/off		oFF	oFF	oFF	oFF	oFF	oFF	oFF	
	U-0 Zero voltage	V	46.0	46.0	46.0	46.0	80.0	46.0	80.0	
	H-0 Hysteresis	V	10.0	10.0	10.0	10.0	10.0	10.0	10.0	
	dRL Response time	s	1.50	1.50	1.50	1.50	1.50	1.50	1.50	
	doF OFF-delay	s	60	60	60	60	60	60	60	
rEL	trEL Response time Yx	s	5.0	5.0 ³	5.0	oFF	oFF	oFF	oFF	
	doFR Mode		ind	ind	ind	ind	ind	ind	ind	
	doFR Off-delay all	s	0	0	0	0	0	0	0	
ddi	ddi Display delay	s	0.5	0.5	0.5	0.5	0.5	0.5	0.5	
	di t Display duration 5Cn	s	3.5	3.5	3.5	3.5	3.5	3.5	3.5	
Si	U Voltage	V	230	230	230	57.7	100	230	400	
	F Frequency	Hz	50.00	50.00	50.00	50.00	50.00	50.00	50.00	
	u5r Vector shift	°	0.0	0.0	0.0	0.0	0.0	0.0	0.0	
CodE	Pr n Pincode		504	504	504	504	504	504	504	
	CodE on / off		oFF	on	oFF	oFF	oFF	oFF	oFF	
	Pr Program		1	2	7	11	12	13	14	

* factory preset ¹ = Autohysteresis 50,05 Hz ² = Autohysteresis 50,10 Hz

³ = Parameter can be changed without unlocking code lock (Pr2 only)

⁴ = Autohysteresis 49,90 Hz

Display of the program: I nFo → Pr

Display of the firmware version: I nFo → Fnr

Info	Fnr	Firmware version		0- 16	0- 16	0- 16	0- 16	0- 16	0- 16	0- 16
	Snr	Serial number		xxxx	xxxx	xxxx	xxxx	xxxx	xxxx	xxxx
	h	Operating hours	h	xxxx	xxxx	xxxx	xxxx	xxxx	xxxx	xxxx
	Err	Error counter		xxx	xxx	xxx	xxx	xxx	xxx	xxx
	Pr	Program		1	2	7	11	12	13	14

4 Connection diagram, 1x section switch (VDE-AR-N 4105:2018-11)

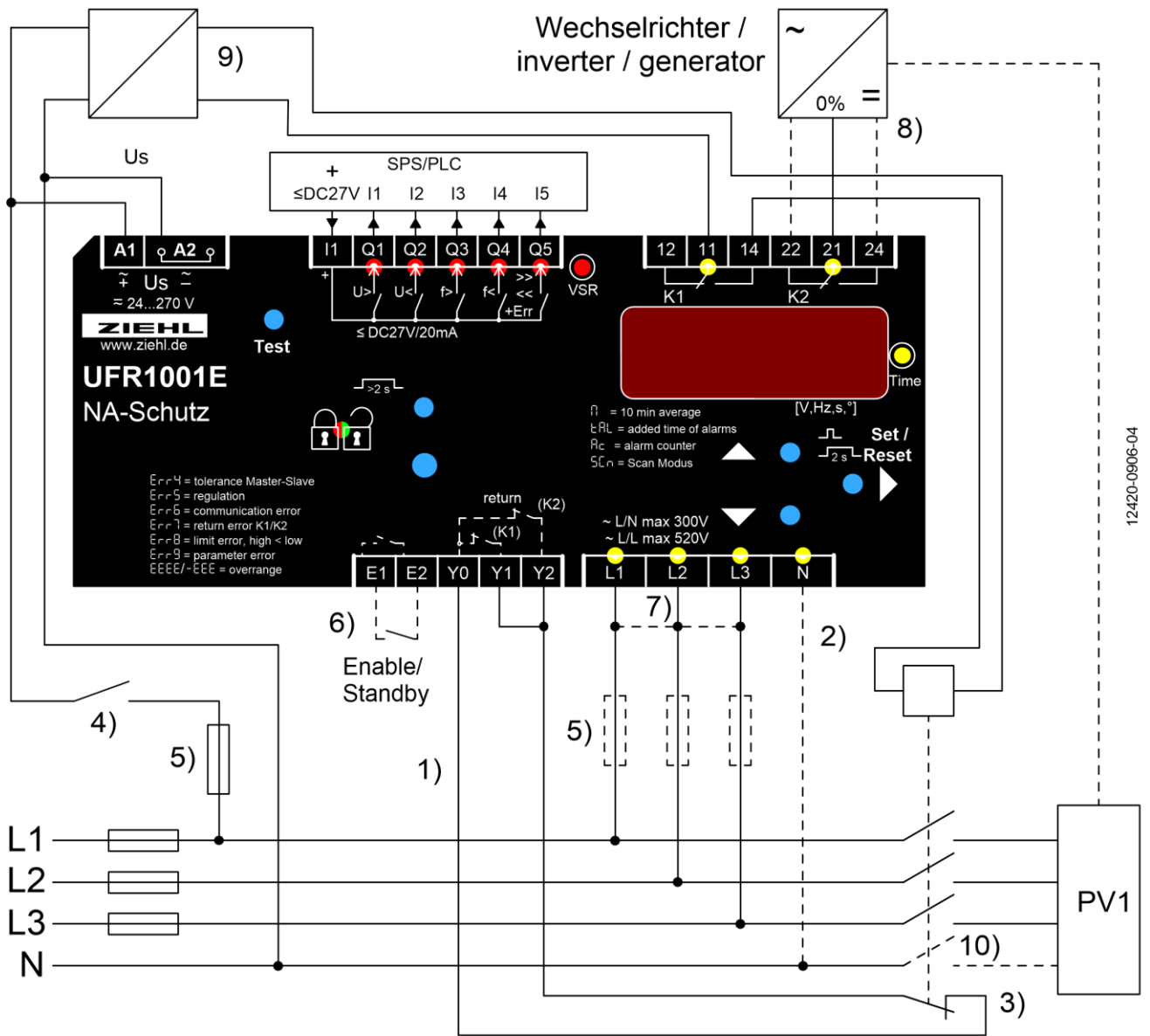

12420-0906-04

- 1) Feedback contacts Y1/Y2 **not** connected set $rEL \rightarrow t_{rEL} \rightarrow off$.
- 2) N connected set $Pr 1$, $Pr 3$ or $Pr 5$
- 3) Nc- or no-contacts can be connected, automatic detection when switching on
- 4) Switch off the plant without recording an alarm, e.g. with output contact of a ripple control receiver
- 5) Fuses only when line protection necessary, e.g. 16 A
- 6) Contact closed suppresses evaluation of feedback contacts and vector shift ($u_{sr} \rightarrow on$) suppresses feedback contacts ($u_{sr} \rightarrow Y1Y2$) or switches device into standby ($u_{sr} \rightarrow StbY$ = default setting) e.g. through ripple control receiver or timer
- 7) 1 phase Application connect L1-L2-L3, 2 phase Application L1 / L2+L3 (only Pr 5, 7, 10, 13, 20)
- 8) Additional switch-off of self generating plant.
Single-fault safety: shutdown of the self generation plant e.g. by ripple control input 0% with K2. Use coupling relays for contact multiplication of if safe isolation is required.
This second shutdown path must be tested separately during commissioning. ($tSt2$)
- 9) Power supply / buffering. Switches have to withstand undervoltage for min. 3 s (FRT)
- 10) TT-system: switch all line conductors and N, TN-system: only switch line conductor

5 Description of the connections

A1 and A2	Rated control supply voltage U_s , see Technical Data (any polarity)
11, 12, 14; 21, 22, 24	Relay K1 and K2
E1 – E2 Enable – Input	Volt-free contact
	$u5r . \rightarrow oFF .$, no function
	$u5r . \rightarrow on .$, E1-E2 closed: vector shift active but not evaluated, monitoring of feedback contacts Y1/Y2 off for use with generator
	$u5r . \rightarrow StbY .$, E1-E2 closed: K1 and K2 off (standby), vector shift off
Y0, Y1, Y2 Inputs, feedback contacts	Volt-free n/o or n/c contact, self-learning when switching on
	Adjust the turn-on time of the section switch under $rEL . \rightarrow ErEL .$, switch-off ($oFF .$) if not connected or if switches are controlled from other device
I1	Supply voltage for digital outputs, max. 27 V DC
Q1...Q4	Digital output over-/undervoltage/-frequency, Q3 + Q4 = ROCOF
Q5	Digital output Error, in Program 3-6 additionally the 2nd threshold value
L1, L2, L3, N	Phase L1, L2, L3 and neutral conductor

6 Important notice



In the supply line in the vicinity of the device (easily accessible), a switch marked as disconnecting device as well as an overcurrent protection element have to be provided.



Attention!
For the rated control supply voltage, see label at the side of the unit!



WARNING

Hazardous electrical voltage!
Can lead to electric shock and burns.
Before starting work, switch plant and device voltage-free.

Comply with the maximum permissible temperature when installing in a switch cabinet. Ensure sufficient clearance to other devices or heat sources. If cooling is inhibited, e.g., through close proximity to devices with increased surface temperature or interference with the cooling-air current, the permissible ambient temperature is decreased.

7 Mounting

The device can be mounted:







- Distribution panel or control panel on 35 mm rail according to EN 60715

8 Disposal

Disposal should be carried out properly and in an environmentally friendly manner in accordance with legal provisions.









9 Program setup

The suitable program must be set on the UFR1001E in accordance with the application. If the UFR1001E is sealed/locked (red LED  lightning), sealing has to be deactivated first.

Pr	Connection	Limit	Voltage	Country / Standard
* 2	3 AC with N	<u>Niederspannung</u> 2x over voltage, 2x under voltage 2x over frequency, 2x under frequency 10min average value, 1x vector shift 1x ROCOF	230V	 VDE-AR-N 4105:2018
1	3 AC with N	<u>Niederspannung</u> 1x over voltage, 1x under voltage 1x over frequency, 1x under frequency 10min average value, 1x vector shift 1x ROCOF	230V	 VDE-AR-N 4105:2011
7	2/1 AC with N			
11(3)	3 AC with N	<u>Mittelspannung</u>	63,5V	 VDE-AR-N 4110:2018 VDE-AR-N 4120:2018 (BDEW Juni 2008 by 3.2.3.3-1)
12(4)	3 AC without N	2x over voltage, 2x under voltage	100V	
13(5)	3/2/1 AC with N	2x over frequency, 2x under frequency 10min average value, 1x vector shift	230V	
14(6)	3 AC without N	1x ROCOF	400V	
10	3/2/1 AC with N	2x over voltage, 2x under voltage 2x over frequency, 2x under frequency 10min average value, 1x vector shift 1x ROCOF	230V	 TOR producers Typ A,B,C,D
15	3 AC with N		230V	 NA/EEA-NE7 CH 2020
20	3/2/1 AC with N	2x over voltage, 2x under voltage	230V	 G98(G83/2) + G99(G59/3)
21	3 AC without N	2x over frequency, 2x under frequency	400V	
22	3 AC with N	10min average value, 1x vector shift	63,5V	
23	3 AC without N	1x ROCOF	110V	
16	3 AC with N	1x over voltage, 1x under voltage 1x over frequency, 1x under frequency 1x ROCOF, zero voltage	230V	 Synergrid C10/C11

* default setting, default settings **Pr 3** ... **Pr 6** , **Pr 10** , **Pr 15** , **Pr 16** , **Pr 20** ... **Pr 23** see <https://www.ziehl.com/en/products/?view=detail&detail=54>

Adjustment process:

• If present, remove seal (only authorised person)
• Apply control supply voltage at A1-A2
• Slightly lift the button cover and turn 180°
• Actuate the small blue button by strong pressing on the button cover (LED starts flashing) until the green LED  is lightning.
• Press button  1x → Display l nFa.
• Press button  5x → Display Pr l.
• Set the program with the buttons  
• Press button  1x → Display no.
• Press button  1x → Display YES.
• Press button 
⇒ Device resets and starts with the newly selected program

Hint: When changing programs, all parameters of the selected program are reset to “default settings” (see table „Default settings“). Only change the parameters after having selected the correct program.

10 Technical data

Rated control supply voltage U_s :

24-270V AC/DC -15...+10 %, DC / 40-70 Hz, <5 VA

Output relays:

- Max. switching voltage
- Inrush current (at 10 % ED)
- Rated operational current I_e (AC15)
- Fuse rating to achieve short-circuit protection

- 2 c/o contacts
- 400 V AC
- 25 A max. 4 s / 50 A max. 1 s
- 230 V AC / 6 A
- max. gG/gL/B 6 A

Output voltage - transistor outputs

- Operational voltage V_Q
- Max. current consumption Q1...Q5

- Q1-Q5
- 4.5-27 V DC
- 20 mA / output

Input circuit - feedback contacts

- No-load voltage at the control inputs

- Y0 – Y1/2
- 15-35 V DC

Subject to change without prior notice

11 Control chart (Pr 1, 7, 15 see Detailed operating manual

<https://www.ziehl.com/en/products/?view=detail&detail=54>

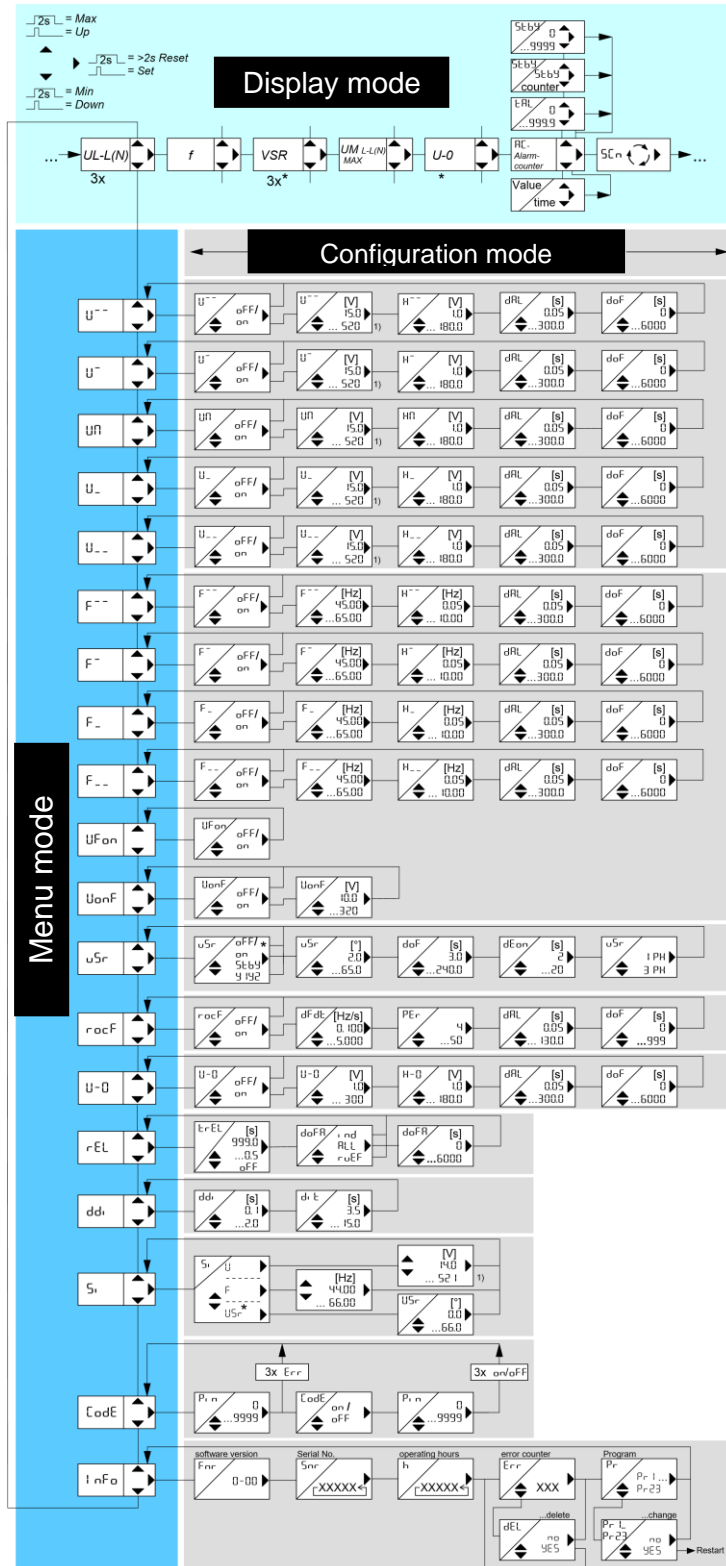

Pr	Connecti on	Country / Standard
2	3 AC + N	VDE-AR-N 4105:2018
11	3 AC + N	VDE-AR-N 4110:2018 4120:2018
12	3 AC	
13	3/2/1 AC + N	
14	3 AC	
3	3 AC + N	BDEW Juni 2008 nach 3.2.3.3-1
4	3 AC	
5	3/2/1 AC + N	
6	3 AC	
10	3/2/1 AC + N	TOR producers type A,B,C,D
15	3 AC +N	NA/EEA-NE7 CH 2020
20	3/2/1 AC + N	G98(G83/2) + G99(G59/3)
21	3 AC	
22	3 AC + N	
23	3 AC	
16	3 AC + N	Synergrid C10/C11

1) 3AC+N = 300V
 *) only displayed if activated
 [] = Unit
 Pressing buttons Up/Down simultaneously, sets the values to the smallest one.
 Code-Reset = Press button Set 2 s while applying control supply voltage. (Pin = 504)
Error reports:
 Err4 = Tolerance Master Slave
 Err5 = internal regulation
 Err6 = communication error
 Err7 = return error K1/K2
 Err8 = limit error high < low
 Err9 = parameter error

12 Troubleshooting

Error	Cause	Remedy
EEEE or -EEE appears in the display	Measured voltage, frequency or the vector shift is too large or too small	Consider the measuring range
Err4 appears in the display	Tolerance error, internal measurement value deviation of both channels	Perform a reset → interrupt the control supply voltage for >5 s *
Err5 appears in the display	Error internal regulation	
Err6 appears in the display	Communication error internal interface	
Err7 appears in the display even after 2 automatic repeated trials of switching on + LED K1 and/or K2 is lightning	Error feedback contacts, switches not connected correctly or broken or switches are controlled from other device	<u>Feedback contacts not connected</u> - set rEL. → tREL. → OFF <u>Feedback contacts connected</u> - check the correct connection - Adjust the turn-on time under rEL. → tREL. greater then the switch-on time of the switcher - Perform a reset → press Set/Reset for >2 s
Err8 appears in the display	Hysteresis error: overlapping of the release points	Upper threshold value must be higher than the lower threshold value, check the threshold values
Err9 appears in the display	Configuration error	Reset to factory settings, see "Program setup" *
A time expires in the display	If a OFF-delay doF is active, the time runs down in the display (the shortest one first)	Wait until the time is complete (depending on the setting, several times may elapse one after the other)
Device cannot be configured / only the threshold values can be configured	Code lock / Sealing activated	When having problems with the code lock (Pin forgotten), the lock can be deactivated and the pin can be reset to 504 , by pressing the button  until CoDE / OFF is shown in the display, while switching on the control supply voltage
Implausible voltage values	Pr selected with N, but N not connected	Select Pr without N or connect N
Loc appears in the display	Sealing is active	See „Program setup“
CoDE appears in the display	Code lock is active	See „Code lock“
StBY appears in the display	Standbymode, E1-E2 closed	check parameter u5r.
RL and LED Q3 (f>) is on, reading value in good range	hysteresis for F~ incorrectly	Check hysteresis for reset point 50,05 Hz
noY1 or noY2 appears in the display	Feedback contact not connected or switch does not switch	Check the connection and function of the switch. Its normal in Pr2 at Test 2 noY2.

* If the error cannot be patched by a reset, send back to factory for repair.